

# SD1g - Glass Applications

SD1g - Glass Applications



## Specifications: SD1g - Glass Applications

## Mounting hardware included

Nominal Impedance	8 ohm
Impedance (min)	8 ohm
Frequency Response ( $\pm 3$ dB)	80 Hz - 10 kHz Nominal w/o EQ
Frequency Response ( $\pm 10$ dB)	60 Hz - 15 kHz Nominal w/o EQ
Max. Program Power	50W , with 100 Hz 12 dB / octave high-pass
Max. Continuous Power RMS	30W
Max. Power SPL @ 1 M	88.5 dB
Enclosure - material	Anodized Aluminum
Height (SM = Height)	52.34 mm / 2.06"
Diameter (SM = Width)	58.60 mm / 2.30"
Weight	0.47 kg / 1.05 lb
Shipping Weight	0.61 kg / 1.35 lb

# SD1g - Glass Applications

## SD1g - Glass Applications



### Key Features

- Proprietary dual-voice coil technology in a durable, aluminum enclosure delivering high power handling and sensitivity across multiple substrates.
  - Symmetrically opposed neodymium magnets convert audio signals into acoustical energy for any rigid surface including glass, drywall, ceramic and wood.
  - Hidden planar-source audio technology evenly distributes acoustic energy throughout the listening space.
  - Proprietary behind-surface mounting technologies ensure maximum visual appeal.
  - 88.5 Max SPL (drywall) and 120° dispersion pattern across the upper registers of the frequency spectrum.
  - Drywall (SD1) optional accessories: self leveling, constant tension pre-construction bracket to ensure proper alignment & wall contact.
  - Glass (SD1g) included accessories: highbond, double-sided VBH adhesive disk.
  - Wood, laminate & composite (SD1sm) included accessories: direct-screw aluminum mounting base.
  - Desktop included accessories: mini amplifier, 15 Volt power supply, passive EQ module, 4 international power outlet adaptors, connector cables and a durable carrying case.
  - Optional accessories include passive EQ modules for drywall, glass or wood; 20 Watt metal junction box for 25, 70.7 & 100 Volt applications (AC-JB20-XFMR) and Heat Sink Fins
  - For extended frequency response, couple SolidDrives with SW7 or SW8 subwoofers.
  - SolidDrives operate in a virtually friction-free environment and are engineered for infinite life.
- SolidDrives come with an industry-leading 7-year warranty.
- UL approved 1480 and 2043 (except SD1- desktop).

### Description

Attaches to glass and other nonporous surfaces using double-sided adhesive disk (included). Each SD1g is designed for one channel of audio. An optional equalization module (listed below) optimizes the SD1g for use on glass.

### Patented SolidDrive Technologies

SolidDrive and MSE Audio Group constantly develop new technologies that enhance audio product performance. SolidDrive innovations are protected by multiple U.S. and international patents, which explicitly cover SolidDrive dispersion, enclosure and dome technologies. MSE Audio Group actively defends its patents in order to protect SolidDrive resellers and end users.

### Technical Data and Specification Tools

#### Technical Data

SolidDrive strives to provide complete and effective technical information and data to dealers, engineers and designers. All data are available from SoundTube Entertainment or at [www.soundtube.com](http://www.soundtube.com). Technical data and downloads include: EASE™ data - 3-D polar plots. EASE™ Address - 2-D modeling for distributed systems Autodesk® Revit® software Tech Sheets - Technical information and architectural specs for system engineers SoundTubeSPEC™ - Proprietary speaker placement software

#### Data Acquisition and Verification

All data for SolidDrive speakers are independently collected from and verified by NWAALabs ([www.nwaalabs.com](http://www.nwaalabs.com)) using their proprietary MACH testing system. All data are collected and analyzed according to ASTM, ISO and AES standards using EASRA,

TEF and MLSSA. Full balloon data including both phase and magnitude are compiled into a variety of formats including EASE 4.x, GLL and CLF.

## SolidDrive EQ Modules

SolidDrive technology and patented mounting mechanisms allow for high quality sound through rigid substrates including drywall, glass, wood, laminate & ceramic. Applications include retail, restaurant, boardroom, tradeshow, presentations and more. With planar-source technology, the location of the SolidDrive on the surface has no impact on the quality or uniformity of the delivered sound field. For bass response down to 40 Hz, SolidDrive SW7 (7 inch) or SW8 (8 inch) subwoofers can be included. An optional 20 Watt transformer is supplied in a junction box and is available for 25, 70.7 or 100 Volt applications.

### Architectural Specifications

The loudspeaker shall consist of a full-range transducer constructed with neodymium magnets in a chrome-plated aluminum enclosure. Performance specifications are dependent upon substrate type and size. Typical production unit specifications are as follows: Useable frequency response shall extend from 60 Hz - 15 kHz (-10 dB, ½ space, no external equalization). Measured sensitivity (2.83 Volt input, 1 meter) shall be at least 70.0 dB (drywall tested). The speaker shall have a nominal impedance of 8 Ohms and rated power capacity shall be at least 30 Watts RMS. The max. SPL shall be 88.5 dB (drywall tested). Installation for the SolidDrive shall include galvanized steel pre-construction bracket for drywall, high-bond, double sided VBH adhesive for glass or direct screw mounting plates for surface-mount applications including wood. The desktop mounting kit includes mini amplifier, 15 Volt power supply, passive EQ module, 4 international power outlet adaptors, connector cables and a durable carrying case. Overall cabinet dimensions for the SD1 and SD1sm shall be no more than 52.8mm (2.08 in) in height by 88.9 mm (3.50 in) in diameter. The SD1 shall weigh no more than 0.50 kg or 1.2 Lbs. Overall cabinet dimensions for the SD1 Desktop and SD1g shall be no more than 52.8 mm (2.08 in) in height by 57.9 mm (2.28 in) in diameter. The SD1 shall weigh no more than 0.50 kg or 1.1 Lbs. SolidDrive models

shall come with the following leads: SD1 - 559 mm (22 in.) plenum rated speaker wire with screw connector block. SD1g - 1829mm (72 in) clear speaker wire with screw connector block. SD1sm - 1829mm (72 in) clear speaker wire with screw connector block. SD1 desktop - 1829mm (72 in) black speaker wire with gold RCA plug.

## SolidDrive

8005 W. 110th St. / Suite 208  
Overland Park, KS 66210  
Phone 913.663.5600  
Fax  
Toll Free 855.663.5600  
<http://soliddrive.mseaudio.com>  
All SolidDrive products come with a 5-year limited warranty.

# SD1g - Glass Applications

SD1g - Glass Applications



## Graphs and Plots

Frequency Response - Typical Dry-wall SolidDrive Response

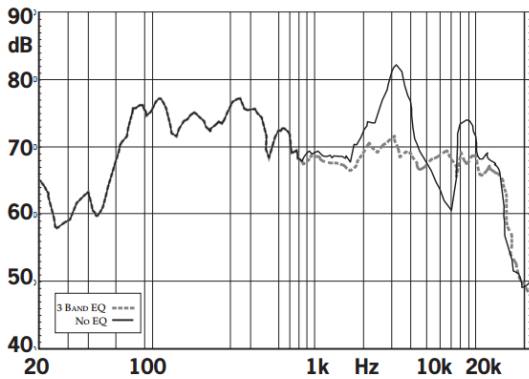

Frequency Response - Typical Wood Table-Top SolidDrive Response

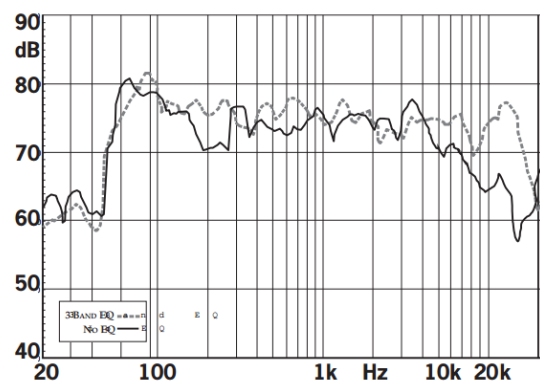

Frequency Response - Typical Glass SolidDrive Response

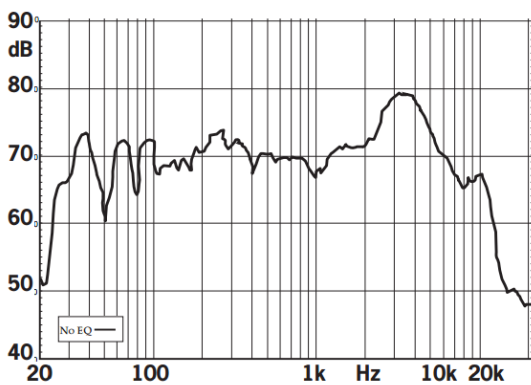

Directivity Index (DI) - Off Axis Response On 4x8' Drywall Panel Outdoors in 4' Direction Referenced to 0deg @2m

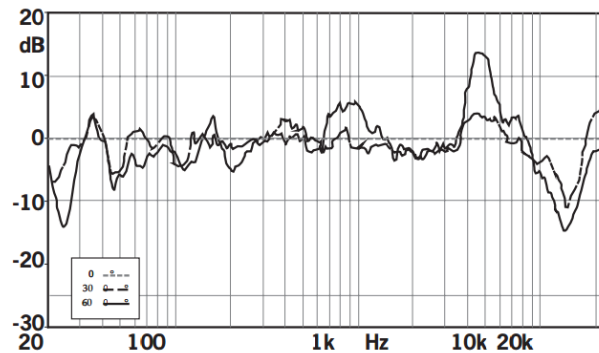

Dry-Wall Passive EQ

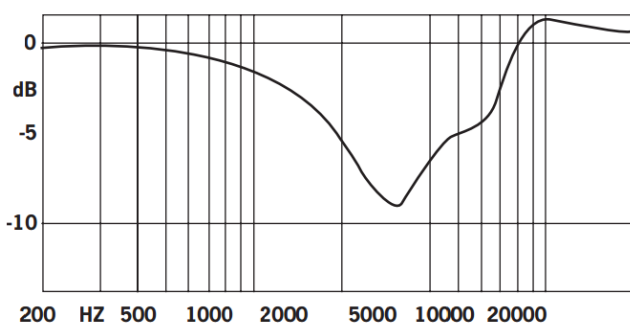

Glass Passive EQ

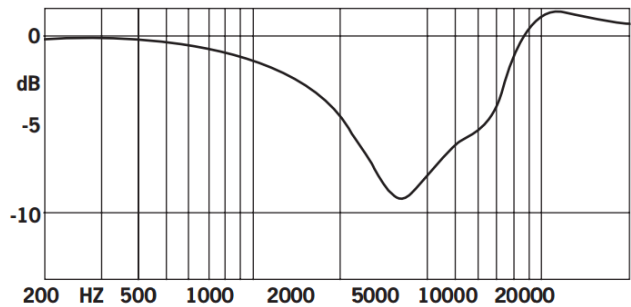

Wood/Desktop Passive EQ

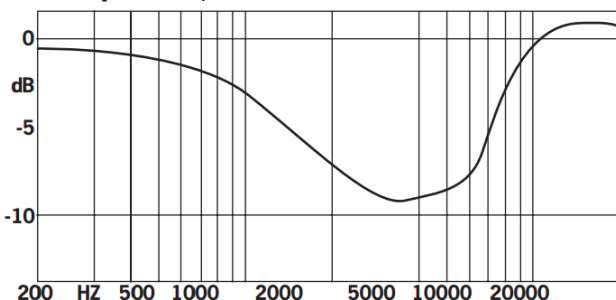

---

# SD1g - Glass Applications

---

SD1g - Glass Applications



# SD1g - Glass Applications

SD1g - Glass Applications



## Mechanical Drawings

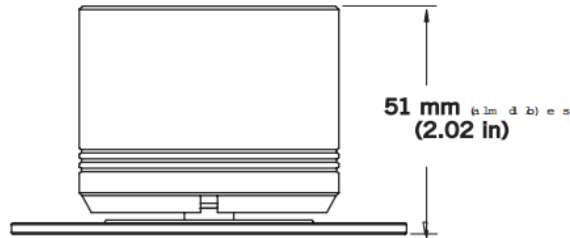
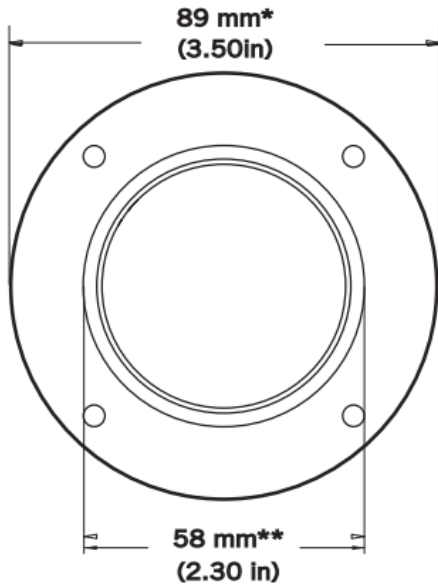

## Optional Accessories

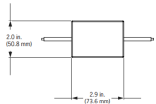

**Passive Equalization Modules**

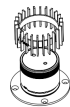

**Heat Sink Fins**