



PRELIMINARY SPECIFICATIONS:

SD-250

System Type	50 w per channel (8 ohm) class D amplifier
Frequency Response	20 Hz - 20 kHz
Max gain	34 dB (8 ohm)
Power per channel @ < 1 % THD	50 watts (8 ohms) 65 watts (4 ohms)
Bridged mono power @ < 1 % THD	90 watts (4 ohms)
Power supply requirement	32 v DC, 3.75A
Signal to noise ratio	> 83 dB (50 watts)
Input impedance	47 kohm
Height	30.5 mm (1.2 in.)
Width	99.1 mm (3.9 in.)
Depth	101.6 mm (4.0 in.)
Weight - amp only	0.26 kg (0.56 lbs)
Packaging	One per box
Included accessories	Power supply, stereo RCA female to mini male adapter, pole/surface mount adapter, two male 4 pin euroblock connectors and two 3-pin euroblock connectors.
Optional accessory (SD-250)	Rack mount adapter (AC-SD-250-RMA)
Regulatory - CE	Approved
RoHS	Approved

Preliminary Technical Information

- 34 dB maximum gain with 2 x 50 watt output.
- Three operating modes: stereo, mono or bridged mono
- Three SolidDrive EQ settings for drywall, wood and glass, plus a full-range flat option (no EQ).
- Three user selectable inputs: balanced stereo euroblock, stereo unbalanced mini jack, or high level euroblock.
- External 12-32 V trigger
- Signal detecting auto standby to conserve energy
- Dual concentric gain controls for independent channel control
- 20 Hz- 20 kHz frequency response
- Small size- 1.2" x 3.9" x 4"
- Rugged aluminum housing
- Optional Accessories: rack mount adapter kit (AC-SD-250-RMA)

Description

The SD-250 is 50-watt per channel (8 ohm) Class D amplifier with maximum gain of 34 dB. Input options include balanced stereo euroblock, unbalanced line level mini jack, and a stereo speaker level (amplified) euroblock input for applications with low wattage speaker outputs. The SD-250 has three operating modes: stereo, dual mono, or bridged mono. In stereo, each input channel flows directly to its corresponding output channel. The SD-250 has three preset EQ settings for use with a SolidDrive speaker in drywall, glass and wood. It also has a flat setting for unequalized full-range amplification. In dual mono, the left input is fed to both output channels. In bridged mono, the left input is fed to the bridged output (4-8 ohm only). System includes selectable 12-32 V external trigger input or auto standby to conserve energy.

Applications

Small, powerful and cost-effective, the SD-250 is engineered for external amplification with SolidDrive and other high-fidelity speakers. Additional applications include digital signage, education, point of purchase, museums, surgical centers, AV carts or any application where a small amplifier is needed to boost a limited source output (e.g., computers, A/V projectors, etc.).

Patented Technologies

SolidDrive and the MSE Audio constantly develop new technologies which enhance audio product performance. SolidDrive innovations are protected by multiple U.S. and international patents, which explicitly cover SolidDrive. The MSE Audio actively defends its patents in order to protect SolidDrive resellers and end-users.

Technical Data and Specification Tools

Technical Data

SolidDrive strives to provide complete and effective technical information and data to dealers, engineers and designers. All data are available from SolidDrive or at www.soliddrive.com.

Technical data and downloads include:

Tech Sheets – Technical information and architectural specs for system engineers

Independent Data Acquisition and Verification

All performance data acquired within MSE Audio are analyzed using a variety of standard measurement techniques, including Maximum Audio Precision Analyzer and Measured Length Sequence (MLS). Performance, development and data acquisition tools include: CLIO, LMS, LEAP, and proprietary modeling software. EASE™ data are acquired through an automated CLIO/ Outline/EASE™ interface.

Architectural Specifications

The amplifier shall be a 50-watt per channel (8 ohm) Class D amplifier.

The amplifier shall provide three inputs including a balanced stereo euroblock, unbalanced line level mini jack, and a stereo speaker level (amplified) euroblock input for applications with low wattage speaker outputs. The SD-250 also includes a variable 34 dB maximum gain control. The amplifier shall provide three operating modes including stereo, dual mono, or bridged mono.

Performance specifications of a typical production unit shall be as follows: 50 watts per channel (20 Hz – 20 kHz, 8 ohm, stereo) or 65 watts per channel (20 Hz – 20 kHz, 4 ohm stereo) at >1% THD. Three preset EQ settings allow the SD-250 to work with an SD1 speaker in drywall, glass and wood applications. The SD-250 also has a full-range option with no EQ setting.

The external wiring output connector shall be a Euroblock connector that accepts from 10 – 22-gauge wire. The power input shall either be by three-pin Euroblock that accepts from 10 – 22-gauge wire or barrel connection. The system shall be for indoor applications.

The enclosure shall be constructed of extruded aluminum with integrated heat-sink. Overall chassis dimensions shall be no more than 30.5 mm (1.2 in.) in height by 99.1 mm (3.9 in.) in width and 101.6 mm (4.0 in.) in depth.

The system shall include the amplifier, pole/surface mount adapter, power supply, stereo RCA female to mini male adapter, two male 4-pin euroblock connectors and two 3-pin euroblock connectors.

The system shall be the SD-250 for amplification.

SolidDrive

6430 North Business Park Loop
Park City, UT 84098
Phone 435.647.5555
Fax 435.647.9666
Toll Free 800.647.TUBE
www.soliddrive.com

All SolidDrive products come with a 7-year limited warranty.

Mechanical Drawings

Included Accessories

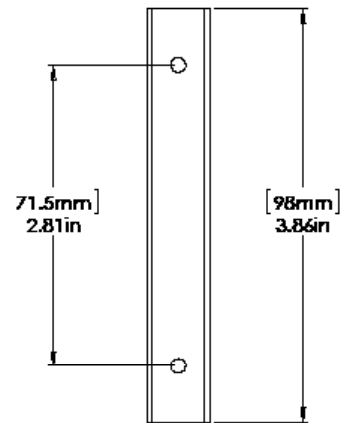
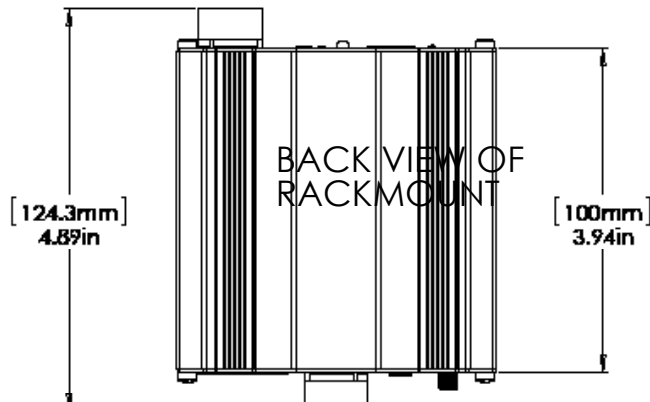
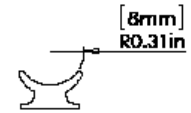
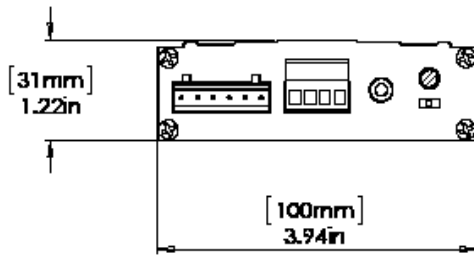

Included Accessories

Rack Mount Adapter (AC-SD-250-RMA)

Dual female RCA to stereo male mini-plug adapter

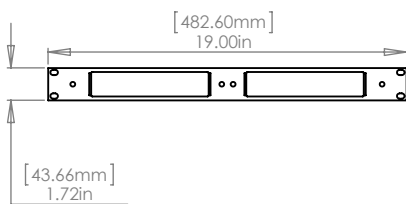

Back view of Rack Mount

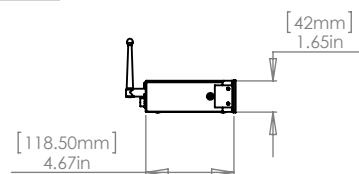
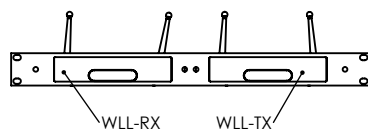
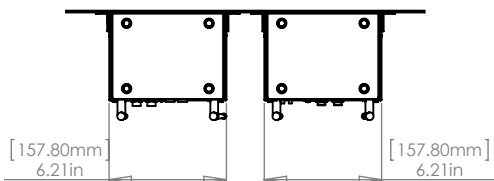
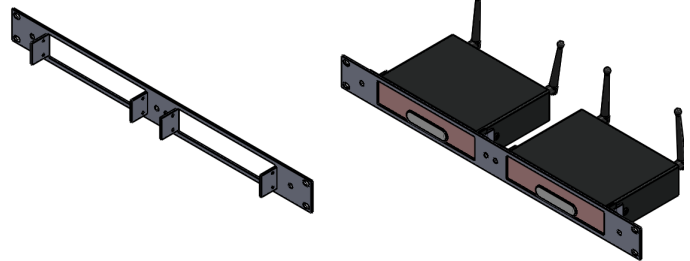

SolidDrive is an MSE Audio Company.

SolidDrive | 6430 N. Business Park Loop | Park City, UT 84098

www.soliddrive.com | www.mseaudio.com